

Estimate numbers on a number line

1 What numbers are the arrows pointing to?

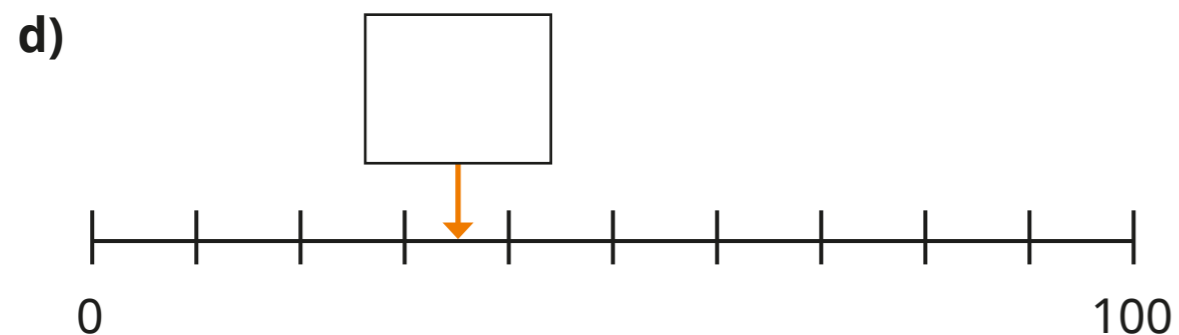
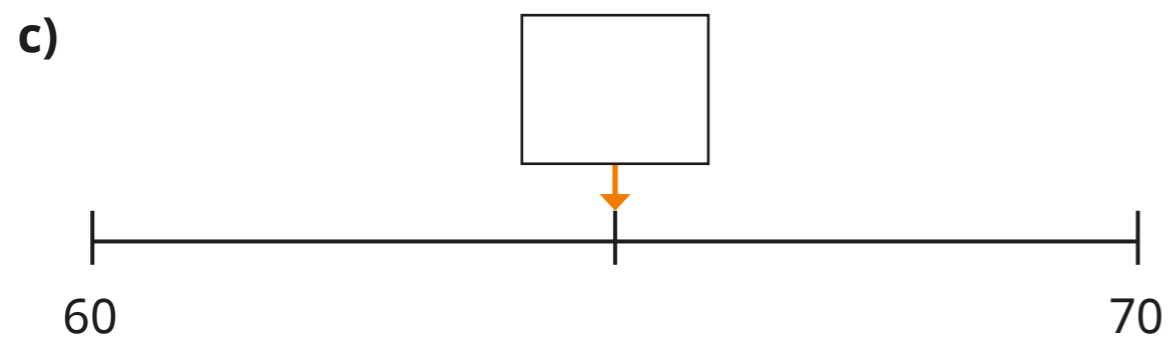
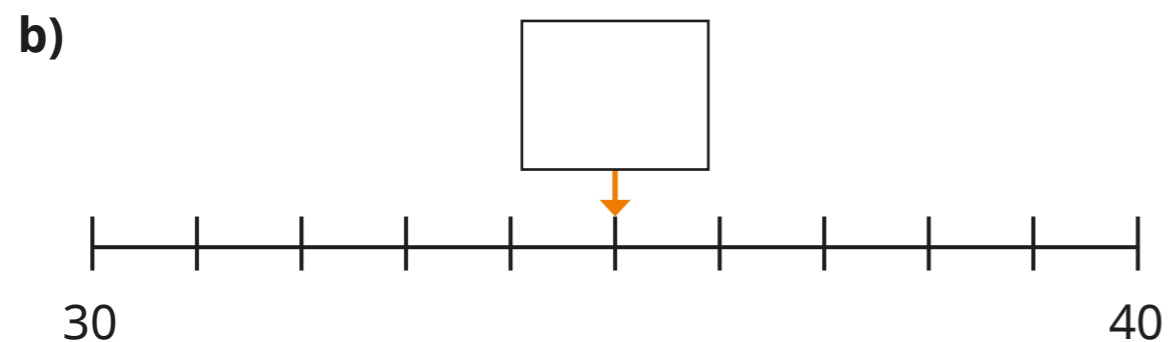
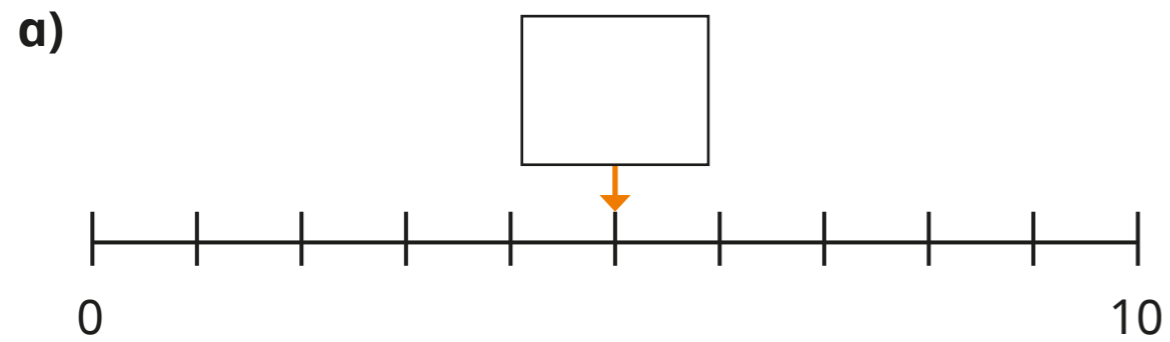

2 Draw arrows to estimate where the numbers belong on the number line.

5	forty-five	75
---	------------	----

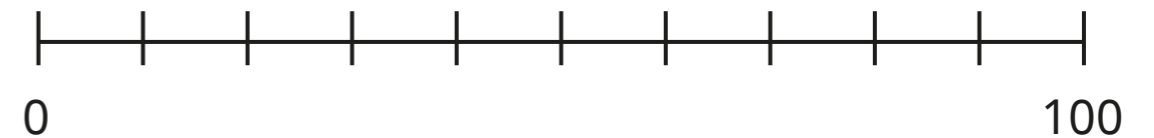

3 The shapes show numbers on a number line.

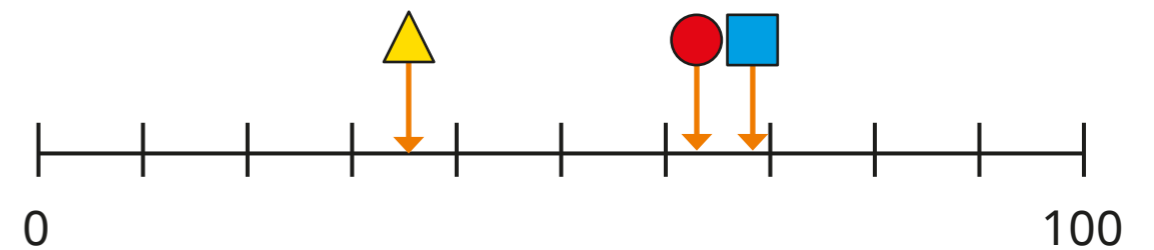

Match the shapes to the numbers.

	63
	36
	68

Talk about your answer with a partner.



- 4 Estimate the numbers the arrows are pointing to.

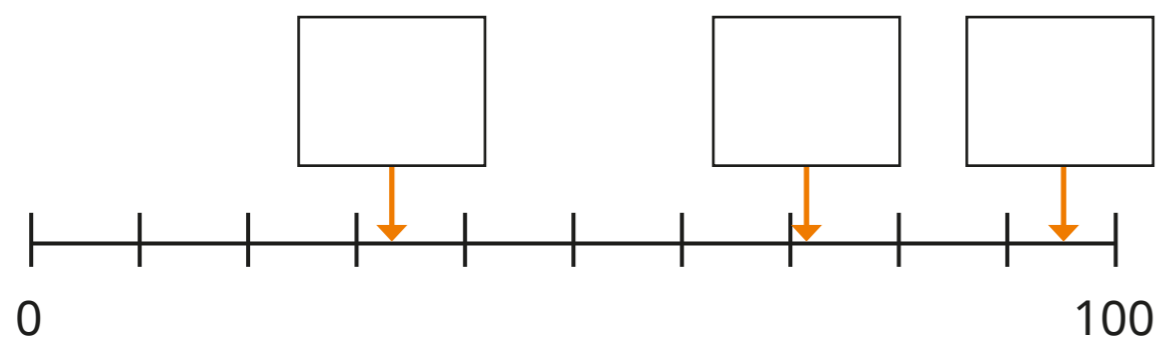

- 5 Draw arrows to estimate where the numbers belong on the number line.

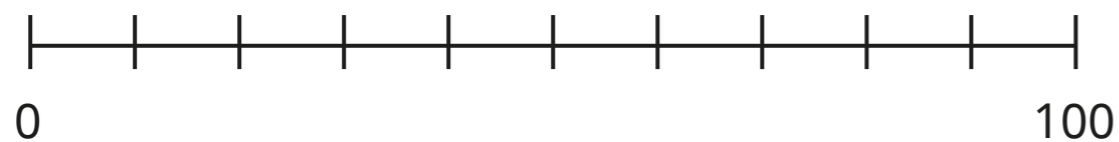
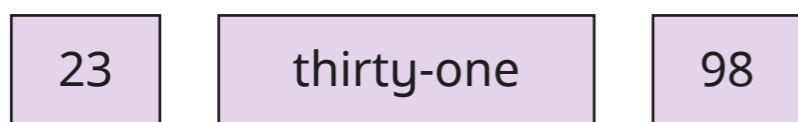

- 6 Ron and Ben estimate where 57 is on the number line.

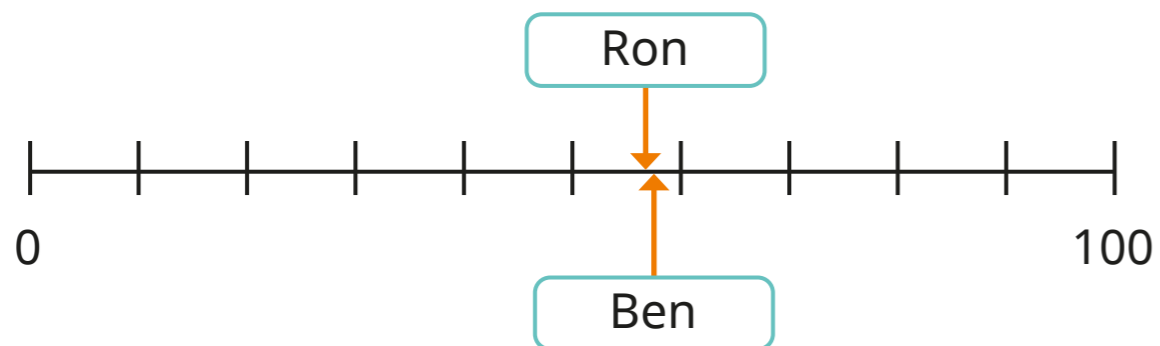

Can Ron and Ben both be correct? _____

How do you know?

- 7 a) Kim labels a number on the number line. She spills some paint over her number. What could Kim's number be?

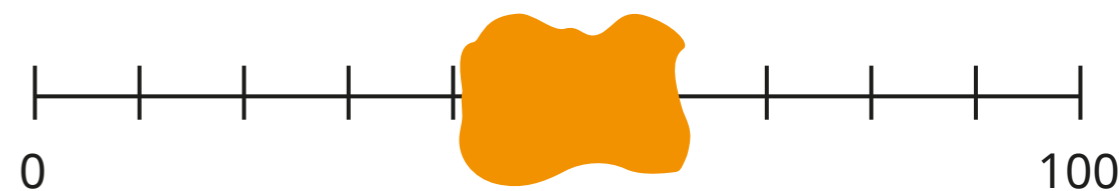

- b) Max labels an odd number on the number line. He spills some paint over his number. What could Max's number be?

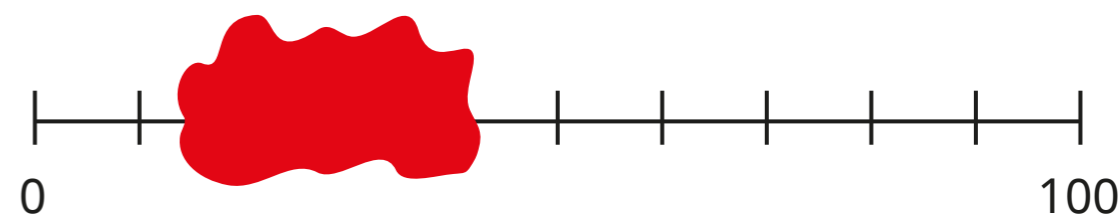

Compare answers with a partner.

